



INSTRUCTION MANUAL

VHF TRANSCEIVER

IC-F3162T/S
IC-F3162DT/DS

UHF TRANSCEIVER

IC-F4162T/S
IC-F4162DT/DS

Icom Inc.



The photo shows the 10-key version UHF transceiver.



IMPORTANT

READ ALL INSTRUCTIONS carefully and completely before using the transceiver.

SAVE THIS INSTRUCTION MANUAL — This instruction manual contains important operating instructions for the **IC-F3162T, IC-F3162S, IC-F3162DT and IC-F3162DS VHF TRANSCEIVERS** and **IC-F4162T, IC-F4162S, IC-F4162DT and IC-F4162DS UHF TRANSCEIVERS**.

 See the operating guide for details of IDAS™, BIIS, MDC and LTR® system operations. Ask your dealer for details.

EXPLICIT DEFENITIONS

WORD	DEFINITION
 DANGER!	Personal death, serious injury or an explosion may occur.
 WARNING!	Personal injury, fire hazard or electric shock may occur.
CAUTION	Equipment damage may occur.
NOTE	If disregarded, inconvenience only. No risk of personal injury, fire or electric shock.

Icom, Icom Inc. and the Icom logo are registered trademarks of Icom Incorporated (Japan) in Japan, the United States, the United Kingdom, Germany, France, Spain, Russia and/or other countries.

IDAS is trademark of Icom Incorporated (Japan).

LTR is a registered trademark of the E.F.Johnson Technologies, INC. in the United States.

All other products or brands are registered trademarks or trademarks of their respective holders.

PRECAUTIONS

⚠ DANGER! NEVER short the terminals of the battery pack.

⚠ DANGER! Use and charge only specified Icom battery packs with Icom radios or Icom chargers. Only Icom battery packs are tested and approved for use with Icom radios or charged with Icom chargers. Using third-party or counterfeit battery packs or chargers may cause smoke, fire, or cause the battery to burst.

⚠ WARNING! NEVER hold the transceiver so that the antenna is very close to, or touching exposed parts of the body, especially the face or eyes, while transmitting. The transceiver will perform best if the microphone is 5 to 10 cm away from the lips and the transceiver is vertical.

⚠ WARNING! NEVER operate the transceiver with a headset or other audio accessories at high volume levels. Hearing experts advise against continuous high volume operation. If you experience a ringing in your ears, reduce the volume level or discontinue use.

⚠ WARNING! NEVER operate the transceiver while driving a vehicle. Safe driving requires your full attention—anything less may result in an accident.

CAUTION: MAKE SURE the flexible antenna and battery pack are securely attached to the transceiver, and that the antenna and battery pack are dry before attachment. Exposing the inside of the transceiver to water will result in serious damage to the transceiver.

DO NOT operate the transceiver near unshielded electrical blasting caps or in an explosive atmosphere.

DO NOT use harsh solvents such as benzine or alcohol when cleaning, as they will damage the transceiver surfaces.

DO NOT push [PTT] when not actually intending to transmit.

DO NOT use or place the transceiver in direct sunlight or in areas with temperatures below -25°C or above $+55^{\circ}\text{C}$.

The basic operations, transmission and reception of the transceiver are guaranteed within the specified operating temperature range. However, the LCD display may not operate correctly, or show an indication in the case of long hours of operation, or after being placed in extremely cold areas.

DO NOT modify the transceiver. The transceiver warranty does not cover any problems caused by unauthorized modification.

PRECAUTIONS (Continued)

BE CAREFUL! The transceiver will become hot when operating it continuously for long periods of time.

KEEP the transceiver away from the heavy rain, and **Never** immerse it in the water. The transceiver meets IP55* requirements for dust-protection and water jet resistance. However, once the transceiver has been dropped, dust-protection and water jet resistance cannot be guaranteed due to the fact that the transceiver may be cracked, or the water-proof seal damaged, etc.

* Only when the supplied battery pack, flexible antenna and connector cover are attached.

MAKE SURE to turn the transceiver power OFF before connecting the supplied/optional equipment.

VOICE CODING TECHNOLOGY

The AMBE+2™ voice coding Technology embodied in this product is protected by intellectual property rights including patent rights, copyrights and trade secrets of Digital Voice Systems, Inc. This voice coding Technology is licensed solely for use within this Communications Equipment. The user of this Technology is explicitly prohibited from attempting to extract, remove, decompile, reverse engineer, or disassemble the Object Code, or in any other way convert the Object Code into a human-readable form. U.S. Patent Nos.

#5,870,405, #5,826,222, #5,754,974, #5,701,390, #5,715,365, #5,649,050, #5,630,011, #5,581,656, #5,517,511, #5,491,772, #5,247,579, #5,226,084 and #5,195,166.

TABLE OF CONTENTS

IMPORTANT	i	4 BATTERY CHARGING	19–23
EXPLICIT DEFENITIONS	i	■ Caution.....	19
PRECAUTIONS.....	ii	■ Optional battery chargers.....	21
VOICE CODING TECHNOLOGY	iii	5 BATTERY CASE.....	24
TABLE OF CONTENTS.....	iv	■ Optional battery case (BP-240).....	24
1 ACCESSORIES	1–3	6 SWIVEL BELT CLIP	25–26
■ Supplied accessories	1	■ MB-93 contents	25
■ Accessory attachments.....	1	■ To attach.....	25
2 PANEL DESCRIPTION.....	4–10	■ To detach.....	26
■ Front panel	4	7 SPEAKER MICROPHONE	27
■ Function display	5	■ Optional HM-169/170GP description	27
■ Programmable function keys	6	■ To attach.....	27
3 BASIC OPERATION	11–18	8 OPTIONS.....	28–31
■ Turning power ON	11	9 COUNTRY CODE LIST	32
■ Channel selection.....	12		
■ Call procedure.....	13		
■ Receiving and transmitting.....	13		
■ User set mode.....	16		
■ Scrambler function	16		
■ Stun function	16		
■ Emergency transmission.....	17		
■ Man Down Emergency Call.....	17		
■ Automatic Key Lock function	18		
■ Priority A channel selection.....	18		

1

2

3

4

5

6

7

8

9

■ Supplied accessories

The following accessories are supplied.

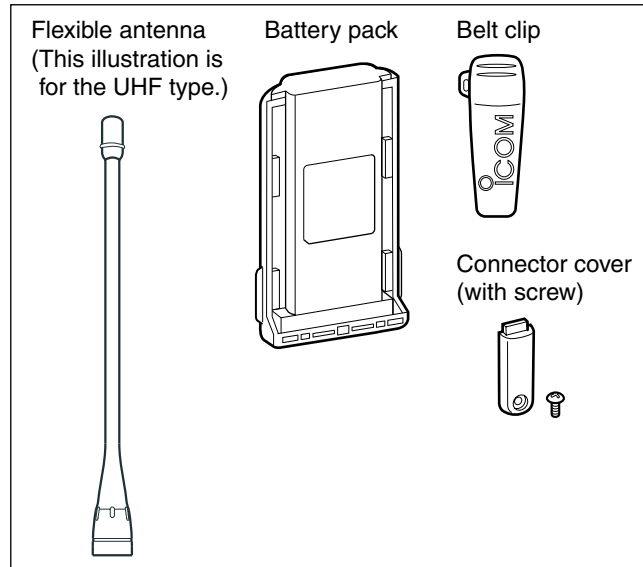

■ Accessory attachments

◇ Flexible antenna

Connect the supplied flexible antenna to the antenna connector.

CAUTION:

- **NEVER** carry the transceiver by holding only the antenna.
- **DO NOT** connect the antenna other than listed on page 29.
- Transmitting without an antenna will damage the transceiver.



◇ Battery pack

To attach the battery pack:

Slide the battery pack on the back of the transceiver in the direction of the arrow (1), then lock it with the battery release button.

- Slide the battery pack until the battery release button makes a 'click' sound.

To remove the battery pack:

Push the battery release button in the direction of the arrow (2) as shown below. The battery pack is then removed.

NEVER remove or attach the battery pack when the transceiver is wet or soiled. This may result water or dust getting into the transceiver/battery pack and may result in the transceiver being damaged.

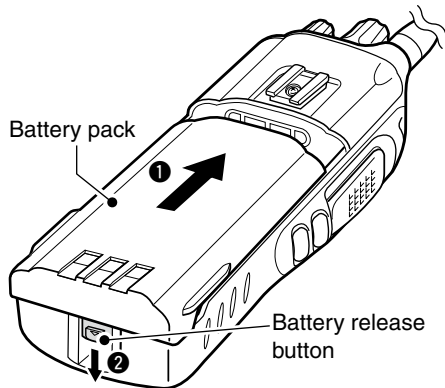

NOTE: Keep the battery pack terminals clean. It's a good idea to occasionally clean them.

◇ Belt clip

To attach the belt clip:

- ① Remove the battery pack if it is attached.
- ② Slide the belt clip in the direction of the arrow until the belt clip is locked and makes a 'click' sound.

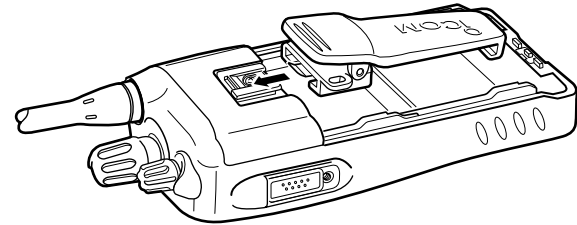

To detach the belt clip:

- ① Remove the battery pack if it is attached.
- ② Pinch the clip (1), and slide the belt clip in the direction of the arrow (2).

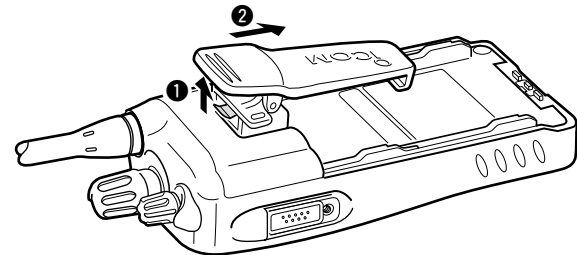

1 ACCESSORIES

◇ Connector cover

To attach the connector cover:

- 1 Insert the connector cover into the multi-connector.
- 2 Tighten the screw.

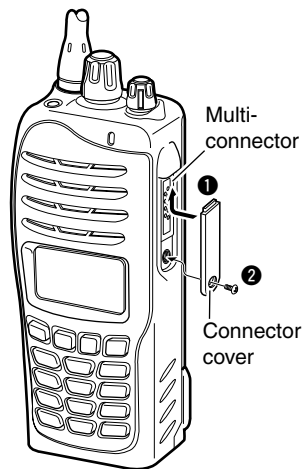

To detach the connector cover:

- 1 Remove the screw using a Phillips screwdriver.
- 2 Detach the connector cover for the optional equipment connector.

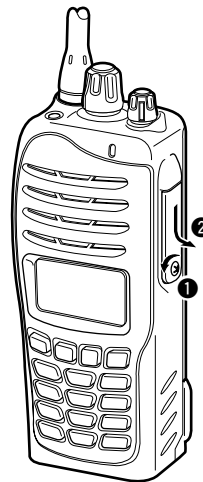

CAUTION:

Attach the connector cover when the optional equipment is not used. Otherwise the terminals of the multi-connector may be shorted by metal object, etc., and this could damage the transceiver.

■ Front panel

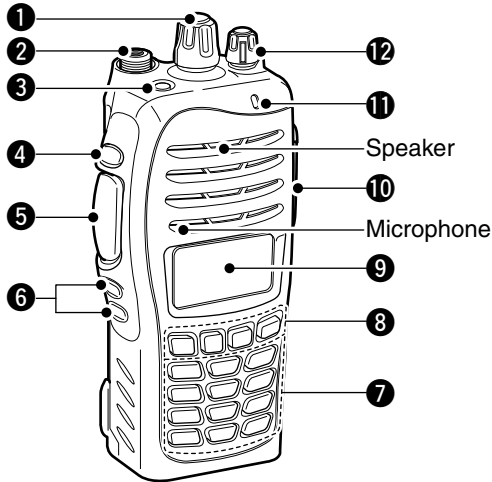

1 ROTARY SELECTOR

Rotate to select the pre-programmed memory channels or the operating zone. (Depending on the pre-setting)

2 ANTENNA CONNECTOR

Connects the supplied antenna. (p. 1)

3 DEALER-PROGRAMMABLE KEY [EMR]

Desired function can be programmed by your dealer. (p. 6)

4 DEALER-PROGRAMMABLE KEY [Side1]

Desired function can be programmed by your dealer. (p. 6)

5 PTT SWITCH [PTT]

Push and hold to transmit; release to receive.

6 DEALER-PROGRAMMABLE KEYS [Side2]/[Side3]

Desired function can be programmed independently by your dealer. (p. 6)

7 10-KEYPAD (Depending on version)

The keypad allows you to enter digits to:

- Select memory channels
- Select tone channels
- Select DTMF codes (during transmit)
- Set TX codes
- Start up with the password

8 DEALER-PROGRAMMABLE KEYS [P0] to [P3]

Desired function can be programmed independently by your dealer. (p. 6)

9 FUNCTION DISPLAY (p. 5)

Displays a variety of information such as an operating channel number/name, Set mode contents, DTMF code, selected function, etc.

2 PANEL DESCRIPTION

⑩ MULTI-CONNECTOR

Connect an optional equipment.

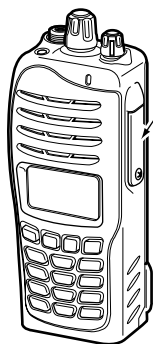

Connector cover

NOTE: Attach the connector cover when the optional equipment is not used. See page 3 for details.

① BUSY/TRANSMIT INDICATOR

- ➔ Lights green while receiving a signal, or when the squelch is open.
- ➔ Lights red while transmitting.

⑫ VOLUME CONTROL [VOL]

Rotate to turn the power ON/OFF and adjusts the audio level.

■ Function display

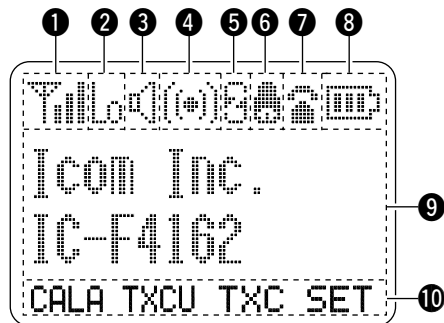

① SIGNAL STRENGTH INDICATOR

Indicates relative signal strength level.

② LOW POWER INDICATOR

Appears when low output power is selected.

③ AUDIBLE INDICATOR

- ➔ Appears when the channel is in the 'audible' (unmute) condition.
- ➔ Appears when the matched signal is received.

④ COMPANDER INDICATOR

Appears when the compander function is activated.

⑤ SCRAMBLER INDICATOR

Appears when the voice scrambler function is activated.

6 BELL INDICATOR

Appears/blinks when the matched signal is received, according to the pre-programming.

7 CALL CODE MEMORY INDICATOR

Appears when the call code memory is selected.

8 BATTERY INDICATOR

Appears or blinks when the battery power decreases to a specified level.

Indication				
Battery level	Full	Middle	Charging required	No battery

blinks when the battery is over charged.

blinks when the battery is exhausted.

9 ALPHANUMERIC DISPLAY

- Displays an operating channel number, channel name, Set mode contents, DTMF code, etc.
- The indication mode can be selected from 1 line or 2 lines. Ask your dealer for details.
 - In this instruction manual, the LCD illustration is described using the 2 lines indication mode.

10 KEY INDICATOR

Indicate the programmed function of the front panel keys ([P0], [P1], [P2] and [P3]).

Programmable function keys

The following functions can be assigned to [EMR], [Side1], [Side2], [Side3], [P0], [P1], [P2] and [P3] programmable function keys.

Consult your Icom dealer or system operator for details concerning your transceivers programming.

If the programmable function names are bracketed in the following explanations, the specific key is used to activate the function depends on the programming.

CH UP AND DOWN KEYS “UP” “DOWN”

- Push to select an operating channel. When [Rotary selector] selects “operating channel,” this key is not available.
- Push to select a transmit code channel after pushing [TX Code CH Select].
- Push to select a DTMF channel after pushing [DTMF Audiotail].
- Push to select a scan group after pushing and holding [Scan].

2 PANEL DESCRIPTION

ZONE KEY “ZONE”

Push this key, then push [CH Up] or [CH Down] to select the desired zone. When [Rotary selector] selects “operating zone,” this key operation is not available.

 **What is “zone”?**— Selected channels are assigned to a zone according to how they are to be used in a group. For example, ‘Staff A’ and ‘Staff B’ are assigned into a “Business” zone, and ‘John’ and ‘Cindy’ are assigned into a “Private” zone.

ZONE UP AND DOWN KEYS “ZNUF” “ZNDN”



Push to select an operating zone. When [Rotary selector] selects “operating zone,” this key is not available.

SCAN KEY “SCAN”

- ➔ Push to start and cancel scanning operation.
 - When Power ON Scan function is activated, push to pause the scanning operation. And the paused scan resumes after the specified time period has passed.
- ➔ Push and hold this key for 1 sec. to indicate the scan list, then push [CH Up] or [CH Down] to select the desired list.

SCAN ADD/DEL (TAG) KEY “SCAD”

- ➔ Push to add channel to, or delete it from the current scan group.
 1. Push to indicate the scan group, then push [CH Up] or [CH Down] to select the desired group.
 2. Push to add or delete the channel to/from the selected scan group.
 3. Push and hold for 1 sec. to exit the scan group selection mode.
- ➔ Push this key while scan is paused (a signal is detected) on a channel (except for priority channel,) the channel is cleared from the scan group.

 Depending on the setting, the cleared channel is added to the scan group again after the scan is cancelled.
 (Nuisance Delete function)

PRIORITY CHANNEL KEYS “PRA” “PRAR” “PRB” “PRBR”

- ➔ Push to select Priority A or Priority B channel.
- ➔ Push and hold [Prio A (Rewrite)] or [Prio B (Rewrite)] for 1 sec. to rewrite the Priority A or Priority B channel for the operating channel.

MEMORY CH 1/2/3/4 KEYS “CH1” “CH2” “CH3” “CH4”

Push to select the memory channels 1 to 4 directly.

MONI KEY “MON”

- Push to mute and release the CTCSS (DTCS) or 2-tone squelch mute. Open any squelch/deactivate any mute while pushing and holding this key. (LMR operation only)
- Activates one of (or two of) the following functions on each channel independently: (PMR operation only)
 - Push and hold to un-mute the channel (audio is emitted; ‘Audible’ condition).
 - Push to mute the channel (sets to ‘Inaudible’ only).
 - Push after the communication is finished to send a ‘reset code’. (5-tone/BIIS operation only)

 **NOTE:** The un-mute condition (‘Audible’ condition) may automatically return to the mute condition (‘Inaudible’ condition) after a specified period.

LIGHT KEY “LIGT”

Push to turn the transceiver’s backlight ON temporarily only when the backlight function is turned OFF in user set mode.

LOCK KEY “LOCK”

- Push and hold for 1 sec. to electronically lock all programmable keys for preventing accidental frequency changes and unnecessary function access except the following: [PTT], [Call] (incl. Call A and Call B), [Moni(Audi)], [Light], [Emergency], [Surveillance], [Lone Worker] and [OPT 1/2/3].
- Push and hold for 1 sec. again to turn the lock function OFF.

LONE WORKER KEY “LONE”

Push to turn the Lone Worker function ON or OFF.

- If the Lone Worker function is activated, the Emergency function is automatically turned ON after the specified time period has passed with no operation is performed.

HIGH/LOW KEY “H/L”

Push to select the transmit output power temporarily or permanently, depending on the pre-setting.

- Ask your dealer for the output power level for each selection.

TONE/RAN CH SELECT KEY “T SEL”

- While in the analog mode operation, push to enter the continuous tone channel selection mode. Then select the desired tone frequency/code setting with [CH Up] or [CH Down]. After the selection, push this key again to set.
- While in the digital mode operation*, push to enter the RAN channel selection mode. Then select the desired RAN setting with [CH Up] or [CH Down]. After the selection, push this key again to set.
- While in the mixed (digital and analog) mode operation*, push to enter the continuous tone channel selection mode. Then select the desired tone frequency/code setting with [CH Up] or [CH Down]. After the selection, push this key to set. After that, the RAN channel selection screen appears. Select the desired RAN setting with [CH Up] or [CH Down]. After the selection, push this key again to set.

* Depending on version, digital and mixed (digital and analog) mode operations are available only when the optional UT-126H DIGITAL MODULATOR/DEMODULATOR UNIT is installed. Ask your dealer for details.

2 PANEL DESCRIPTION

TALK AROUND KEY “TA”

Push to turn the talk around function ON and OFF.

- The talk around function equalizes the transmit frequency to the receive frequency for transceiver-to-transceiver communication.

WIDE/NARROW KEY “W/N”

Push to toggle the IF bandwidth between wide and narrow.

DTMF AUTODIAL KEY “DTMA”

Push to enter the DTMF channel selection mode. Then select the desired DTMF channel using [CH Up]/[CH Down]. After selecting the DTMF channel, push again to transmit the selected DTMF code.

RE-DIAL KEY “DTMR”

Push to transmit the last-transmitted DTMF code.

CALL KEYS “CALL” “CALA” “CALB”

Push to transmit a 2/5-tone or BIIS ID code.

- Call transmission is necessary before you call another station depending on your signaling system.
- [Call A] and/or [Call B] may be available when your system employs selective ‘Individual/Group’ calls. Ask your dealer which call is assigned to each key.

EMERGENCY KEY “EMR”

Push and hold to transmit the emergency call.

- The emergency call transmits with beeps; the display does not change.
- The transceiver can transmit the emergency call silently or with the display changes depending on the pre-setting. Ask your dealer for details.
- If you want to cancel the emergency call, push and hold the key again before transmitting the call.
- The emergency call is transmitted one time only or repeatedly until receiving a control code, depending on the pre-setting.

SURVEILLANCE KEY “SURV”

Push to turn the surveillance function ON or OFF.

When this function is turned ON, the beep is not emitted and the LCD backlight does not light when a signal is received or a key is pushed, etc.

TX CODE ENTER KEYS “TXCE”

Push to enter the ID code edit mode directly, for both 5-tone and MSK. Then set the desired digit using [CH Up]/[CH Down]. (p. 15)

TX CODE CHANNEL SELECT KEY "TXC"

Push to enter the TX code channel selection mode. Then set the desired channel using [CH Up]/[CH Down]. (pp. 14, 15)

TX CODE CHANNEL UP/DOWN KEYS "TXCU" "TXCD"

Push to select a TX code channel directly.

ID-MEMORY SELECT KEY "IDMS"

- Recalls detected ID codes.
 - Push this key, then select the ID code using [CH Up]/[CH Down].
 - Up to 5 ID's are memorized.
- Push and hold for 1 sec. to erase the selected ID's.

SCRAMBLER/ENCRYPTION KEY "SCR"

- While in the analog mode operation, push to toggle the voice scrambler function ON and OFF.
- While in the digital mode operation*, push to toggle the encryption transmission function ON and OFF.

* Depending on version, digital mode operation is available only when the optional UT-126H DIGITAL MODULATOR/DEMODULATOR UNIT is installed. Ask your dealer for details.

COMPANDER KEY "COMP"

Push to toggle the compander function ON and OFF. The compander function reduces noise components from the transmitting audio to provide clear communication.

USER SET MODE KEY "SET"

- Push and hold for 1 sec. to enter user set mode.
 - During in the user set mode, push this key to select an item that is enabled by your dealer, and change the value or condition by pushing [CH Up] or [CH Down].
- Push and hold this key for 1 sec. again to exit user set mode.

OPT OUT KEYS "OP1" "OP2" "OP3"

Push to control the output signal level from the optional unit connector.

OPT MOMENTARY KEYS "O1M" "O2M" "O3M"

Push to control the output signal level from the optional unit connector.

■ Turning power ON

 Prior to using the transceiver for the first time, the battery pack must be fully charged for optimum life and operation. (p. 19)

- ① Rotate [VOL] to turn the power ON.
- ② If the transceiver is programmed for a start up password, input the digit codes as directed by your dealer.
 - 10-keypad can be used for password input depending on version.
 - The keys in the table below can be used for password input.
 - The transceiver detects numbers in the same block as identical. Therefore “01234” and “56789” are the same.

KEY	P ₀	P ₁	P ₂	P ₃	(Side1)
NUMBER	0 5	1 6	2 7	3 8	4 9

- ③ When the “PASSWORD” indication does not clear after inputting 6 digits, the input code number may be incorrect. Turn the power off and start over in this case.

◇ Battery type selection

The battery type must be selected according to the attaching battery type when tuning the transceiver ON.

- ➔ While pushing and holding [Emer] and [PTT], rotate [VOL] to toggle the attaching battery type.
 - After the display appears, release [Emer] and [PTT].
 - “DRY BATT” is displayed for about 3 sec. then “Lo” (low power indicator) appears when the battery case operation is selected.
 - “LI-ION” is displayed for about 3 sec. when the Lithium-ion battery operation is selected.
- This operation may not be available depending on the pre-setting. Ask your dealer for details.

■ Channel selection

Several types of channel selections are available. Methods may differ according to your system set up.

NON-ZONE TYPE:

To select the desired operating channel:

- Push [CH Up] or [CH Down].
- Rotate [ROTARY SELECTOR]*.
 - Up to pre-programmed 16 channels can be selected.
- Push one of [MR-CH 1] to [MR-CH 4].

ZONE TYPE:

To select the desired zone:

- Push [Zone], then push [CH Up] or [CH Down].
- Push [Zone Up] or [Zone Down].
- Rotate [ROTARY SELECTOR]*.
 - Up to pre-programmed 16 zones can be selected.

◇ **Voting operation**

The transceiver automatically starts scanning when a zone, specified for the voting operation, is selected.

The voting scan detects the S-meter of the repeater and automatically selects the strongest station.

AUTOMATIC SCAN TYPE:

Channel setting is not necessary for this type. When turning power ON, the transceiver automatically starts scanning. Scanning stops when receiving a call.

* Depending on the pre-setting.

When [Rotary selector] selects "Operating channel," [CH Up]/[CH Down] are not available.

When [Rotary selector] selects "Operating zone," [Zone]/[Zone Up]/[Zone Down] are not available.

3 BASIC OPERATION

■ Call procedure

When your system employs tone signalling (excluding CTCSS and DTCSS), this call procedure may be necessary prior to voice transmission. The tone signalling employed may be a selective calling system which allows you to call specific station(s) only and prevent unwanted stations from contacting you.

- ① Select the desired TX code channel or 2/5-tone code according to your System Operator's instructions.
 - This may not be necessary depending on programming.
 - Refer to pages 14 or 15 for selection.
- ② Push [Call] (assigned to one of the dealer programmable keys)
- ③ After transmitting, the remainder of your communication can be carried out in the normal fashion.

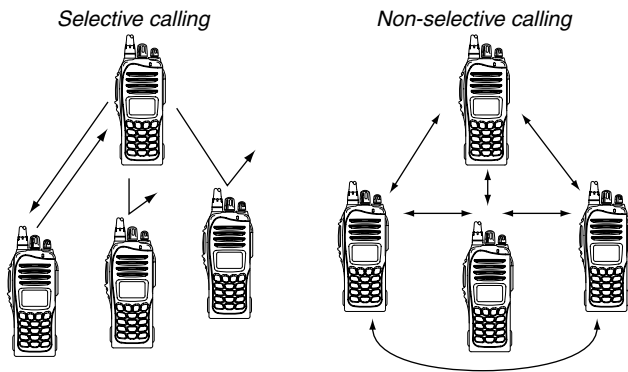

■ Receiving and transmitting

CAUTION: Transmitting without an antenna may damage the transceiver. See page 1 for accessory attachments.

Receiving:

- ① Rotate [VOL] to turn the power ON.
- ② Push [CH Up] or [CH Down], or rotate [ROTARY SELECTOR]* to select the conventional system channel, in sequence.
 - *Depending on the pre-setting.
- ③ When receiving a call, adjust the audio output level to a comfortable listening level.

NOTE: When a matched RX code signal is received, audio from the microphone is automatically transmitted for a specified time period.*

* Depending on the presetting. Ask your dealer for details.

Transmitting:

Wait for the channel to become clear to avoid interference.

- ① While pushing and holding [PTT], speak into the microphone at a normal voice level.
 - When a tone signalling system is used, the call procedure described at the previous page may be necessary.
- ② Release [PTT] to return to receive.

IMPORTANT: To maximize the audio quality of your signal;

1. Pause briefly after pushing [PTT].
2. Hold the microphone 5 to 10 cm from your mouth, then speak into the microphone at a normal voice level.

◇ Transmitting notes

• Transmit inhibit function

The transceiver has several inhibit functions which restrict transmission under the following conditions:

- The channel is in mute condition ('Inaudible' condition; "🔇" (Audible indicator) does not appear.)
- The channel is busy.
- Un-matched (or matched) CTCSS is received. (Depending on the pre-setting.)
- The selected channel is a 'receive only' channel.

• Time-out timer

After continuous transmission for the pre-programmed time period, the time-out timer starts, causing the transceiver to stop transmitting.

• Penalty timer

Once the time-out timer starts, transmission is further inhibited for a period determined by the penalty timer.

◇ TX code channel selection

If the transceiver has [TX Code CH Select] assigned to it, the indication can be toggled between the operating channel number (or name) and TX code channel number (or name). When the TX code channel number (or name) is displayed, [CH Up] or [CH Down] selects the TX code channel.

USING [TX CODE CH SELECT] KEY:

- ① Push [TX Code CH Select]— a TX code channel number (or name) appears.
- ② Push [CH Up] or [CH Down] to select the desired TX code channel.
- ③ After selecting, push [TX Code CH Select] to set.
 - Return to the stand-by mode.
- ④ Push [Call] to transmit the selected TX code.

USING [TX CODE CH UP]/[TX CODE CH DOWN] KEY:

If the transceiver has a [TX Code CH Up] or [TX Code CH Down] key assignment, the programmed TX code channel can be selected directly when pushed.

3 BASIC OPERATION

◇ TX code number edit (PMR operation only)

If the transceiver has [TX Code CH Select] or [TX Code Enter] assigned to it, TX code contents can be edited within the allowable digits.

USING [TX CODE CH SELECT] KEY:

- ① Push [TX Code CH Select] to enter the TX code channel selection mode.
 - Select the desired operating channel before entering the TX code channel selection mode if necessary.
- ② Push [TX Code CH Select] for 1 sec. to enter the TX code edit mode.
 - The digit to be edited blinks.
- ③ Push [TX Code CH Select] to select the desired digit to be edited.
- ④ Push [CH Up]/[CH Down] to select the desired digit.
- ⑤ Push [TX Code CH Select] to set. The digit to the right will blink automatically.
- ⑥ Repeat ④ and ⑤ to edit all allowable digits.
- ⑦ After editing, push [TX Code CH Select] to set.
 - Return to the stand-by mode.
- ⑧ Push [Call] to transmit.

USING [TX CODE ENTER] KEY:

- ① After pushing [TX Code CH Select], push [CH Up] or [CH Down], or push [TX Code CH Up] or [TX Code CH Down] to select the desired TX code channel.
- ② Push [TX Code Enter] to enter the TX code edit mode.
 - The digit to be edited blinks.
- ③ Push [TX Code Enter] to select the desired digit to be edited.
- ④ Push [CH Up]/[CH Down] to select the desired digit.
- ⑤ Push [TX Code Enter] to set. The digit to the right will blink automatically.
- ⑥ Repeat ④ and ⑤ to edit all allowable digits.
- ⑦ After editing, push [TX Code Enter] to set.
 - Return to the stand-by mode.
- ⑧ Push [Call] to transmit.

◇ DTMF transmission

If the transceiver has [DTMF Autodial] assigned to it, the automatic DTMF transmission function is available. Up to 8 DTMF channels are available.

- ① Push [DTMF Autodial]— a DTMF channel appears.
- ② Push [CH Up] or [CH Down] to select the desired DTMF channel.
- ③ Push [DTMF Autodial] to transmit the DTMF code.

■ User set mode

You can “customize” the transceiver operation to suit your preferences and operating style.

Entering the user set mode:

- ① Hold down [User Set Mode] for 1 second to enter the user set mode.
- ② Push [User Set Mode] one or more times to select the appropriate item. Then push [CH Up] or [CH Down] to set the desired level or condition.
 - In the user set mode, the selectable items are preset by your dealer. The presettable items are **Backlight**, **LCD contrast**, **Beep**, **Beep Level**, **Ringer Level**, **SQL Level**, **AF Min Level**, **Mic Gain**, **VOX Gain***, **VOX Delay***, **Battery Voltage**, **Signal Moni**, **Lone Worker** and **System Info**.
 - * Appear only when the external VOX unit is connected.
- ③ Hold down [User Set Mode] for 1 second again to exit the set mode.

■ Scrambler function

The voice scrambler function provides private communication between stations. All versions have a built-in frequency inversion type scrambler; however, an optional rolling or non-rolling type is available as well.

- ➔ Push [Scrambler] to toggle the scrambler function ON or OFF.
 - “” (Scrambler indicator) appears when the function is ON.

■ Stun function

When the specified ID, set as a stun ID or kill ID, is received, the stun function is activated.

When the stun ID is received, the transceiver becomes unusable. Entering of the password (p. 11) or receiving a specified ID, set as a revive ID, is necessary to operate the transceiver again in this case.

When the kill ID is received, the transceiver switches to the cloning required condition. Cloning the transceiver is necessary to operate the transceiver again in this case.

3 BASIC OPERATION

■ Emergency transmission

When [Emergency] is pushed for the specified time period*, the emergency signal is transmitted once, or repeatedly, on the specified emergency channel.

A repeat emergency signal is automatically transmitted until the transceiver receives an acknowledgement signal, or you turn the transceiver power OFF.

When no emergency channel is specified, the signal is transmitted on the operating channel.

If you want to cancel the emergency call, push and hold [Emergency] again before transmitting the call.

If your transceiver is programmed for Silent operation, you can transmit an Emergency call without the beep sounding and the LED indicator lighting.

 **IMPORTANT:** It is recommended to set an emergency channel individually to provide the certain emergency call operation.

* Depending on the presetting. Ask your dealer for details.

◇ NOTES

Depending on the presetting, the following functions are automatically activated. Ask your dealer for details.

• Auto TX function

After the emergency call transmission, audio from the microphone is automatically transmitted for a specified time period.*

• Auto RX function

After the emergency call transmission, the transceiver stands by in the audible mode for the specified time period.*

■ Man Down Emergency Call

This function requires the optional UT-124R MAN DOWN UNIT. When the transceiver has been left in a horizontal position for the specified time period*, the transceiver enters the emergency mode, and then the countdown starts. After the specified time period* has passed, an emergency call is automatically transmitted once, or repeatedly.

If the transceiver is placed in a vertical position before the first transmission, the transceiver exits the emergency mode and the emergency call is cancelled.

■ Automatic Key Lock function

When [Lock] is assigned to any key and the Automatic Key Lock timer is pre-programmed* by your dealer, the key lock function can be automatically turned ON after the specified time period has passed without operation during standby condition.

While the lock function is ON, push and hold [Lock] for 1 sec. to turn the function OFF.

*When "0" is programmed, this function is not available.

■ Priority A channel selection

When one of the following operations is performed, the transceiver selects the Priority A channel automatically.

- Turning the power ON
The Priority A channel is selected each time the transceiver power is turned ON.
- Status call
The Priority A channel is selected when transmitting a status call. (BIIS operation only)
- Clear down
The Priority A channel is selected after the clear down signal is transmitted.

■ Caution

Misuse of Lithium-ion batteries may result in the following hazards: smoke, fire, or the battery may rupture. Misuse can also cause damage to the battery or degradation of battery performance.

- **⚠ DANGER!** Use and charge only specified Icom battery packs with Icom radios or Icom charger. Only Icom battery packs are tested and approved for use and charge with Icom radios or Icom charger. Using third-party or counterfeit battery packs or charger may cause smoke, fire, or cause the battery to burst.

◇ Battery caution

- **⚠ DANGER! DO NOT** hammer or otherwise impact the battery. Do not use the battery if it has been severely impacted or dropped, or if the battery has been subjected to heavy pressure. Battery damage may not be visible on the outside of the case. Even if the surface of the battery does not show cracks or any other damage, the cells inside the battery may rupture or catch fire.
- **⚠ DANGER! NEVER** use or leave battery packs in areas with temperatures above +60°C. High temperature buildup in the battery, such as could occur near fires or stoves, inside a sun heated car, or in direct sunlight may cause the battery to rupture or catch fire. Excessive temperatures may also degrade battery performance or shorten battery life.

- **⚠ DANGER! DO NOT** expose the battery to rain, snow, seawater, or any other liquids. Never charge or use a wet battery. If the battery gets wet, be sure to wipe it dry before using. The battery is not waterproof.
- **⚠ DANGER! NEVER** incinerate used battery packs since internal battery gas may cause them to rupture, or may cause an explosion.
- **⚠ DANGER! NEVER** solder the battery terminals or NEVER modify the battery pack. This may cause heat generation, and the battery may rupture, emit smoke or catch fire.
- **⚠ DANGER!** Use the battery only with the transceiver for which it is specified. Never use a battery with any other equipment, or for any purpose that is not specified in this instruction manual.
- **⚠ DANGER!** If fluid from inside the battery gets in your eyes, blindness can result. Rinse your eyes with clean water, without rubbing them, and see a doctor immediately.
- **⚠ WARNING!** Immediately stop using the battery if it emits an abnormal odor, heats up, or is discolored or deformed. If any of these conditions occur, contact your Icom dealer or distributor.
- **⚠ WARNING!** Immediately wash, using clean water, any part of the body that comes into contact with fluid from inside the battery.

- **⚠ WARNING! NEVER** put the battery in a microwave oven, high-pressure container, or in an induction heating cooker. This could cause a fire, overheating, or cause the battery to rupture.
- **CAUTION:** Always use the battery within the specified temperature range for the transceiver (-25°C to $+55^{\circ}\text{C}$) and the battery itself (-20°C to $+60^{\circ}\text{C}$). Using the battery out of its specified temperature range will reduce the battery's performance and battery life. Please note that the specified temperature range of the battery may exceed that of the transceiver. In such cases, the transceiver may not work properly because it is out of its operating temperature range.
- **CAUTION:** Shorter battery life could occur if the battery is left fully charged, completely discharged, or in an excessive temperature environment (above $+50^{\circ}\text{C}$) for an extended period of time. If the battery must be left unused for a long time, it must be detached from the radio after discharging. You may use the battery until the remaining capacity is about half, then keep it safely in a cool dry place with the temperature range as below:
 - 20°C to $+50^{\circ}\text{C}$ (within a month)
 - 20°C to $+40^{\circ}\text{C}$ (within three months)
 - 20°C to $+20^{\circ}\text{C}$ (within a year)

◇ Charging caution

- **⚠ DANGER! NEVER** charge the battery pack in areas with extremely high temperatures, such as near fires or stoves, inside a sun heated car, or in direct sunlight. In such environments, the safety/protection circuit in the battery will activate, causing the battery to stop charging.
- **⚠ WARNING! NEVER** charge or leave the battery in the battery charger beyond the specified time for charging. If the battery is not completely charged by the specified time, stop charging and remove the battery from the battery charger. Continuing to charge the battery beyond the specified time limit may cause a fire, overheating, or the battery may rupture.
- **⚠ WARNING! NEVER** insert the transceiver (battery attached to the transceiver) into the charger if it is wet or soiled. This could corrode the battery charger terminals or damage the charger. The charger is not waterproof.
- **CAUTION: NEVER** charge the battery outside of the specified temperature range: BC-160 (0°C to $+40^{\circ}\text{C}$). Icom recommends charging the battery at $+20^{\circ}\text{C}$. The battery may heat up or rupture if charged out of the specified temperature range. Additionally, battery performance or battery life may be reduced.

4 BATTERY CHARGING

■ Optional battery chargers

◇ Rapid charging with the BC-160

The optional BC-160 provides rapid charging of the Li-ion battery pack.

Charging period: Approximately 3 hours (with BP-232H)

The following items are additionally required:

- An AC adapter (may be supplied with BC-160 depending on version) or the DC power cable (OPC-515L/CP-23L).

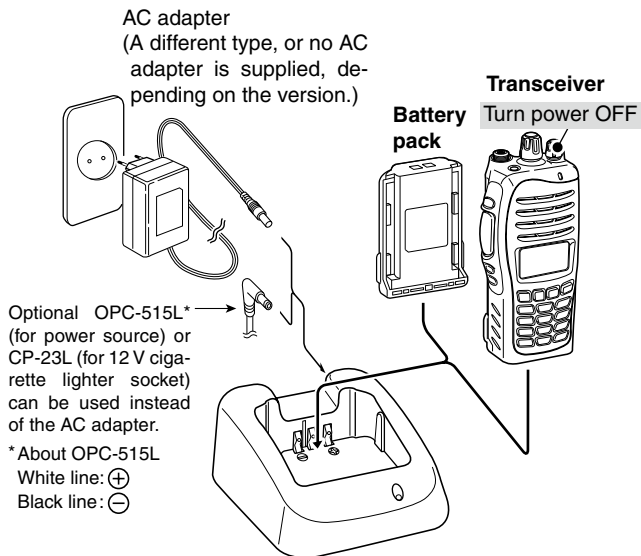

◇ Regular charging with the BC-171

The optional BC-171 provides regular charging of the Li-ion battery pack.

Charging period: Approximately 4 hours (with BP-230N)

The following items are additionally required:

- An AC adapter (may be supplied with BC-171 depending on version) or the DC power cable (OPC-515L/CP-23L).

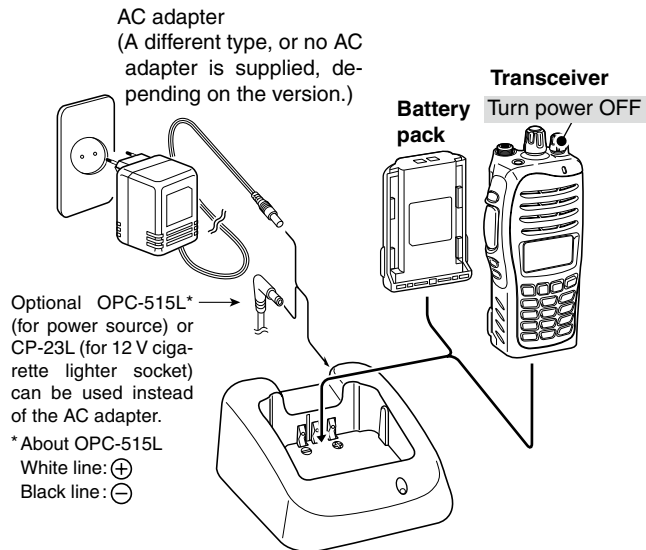

◇ **AD-106 installation**

The AD-106 CHARGER ADAPTER must be installed into the BC-119N or BC-121N before battery charging.

- ① Attach the plugs from the BC-119N/BC-121N to the AD-106 CHARGER ADAPTER.
- ② Secure the AD-106 into the holder space of the BC-119N/BC-121N with the supplied screws.

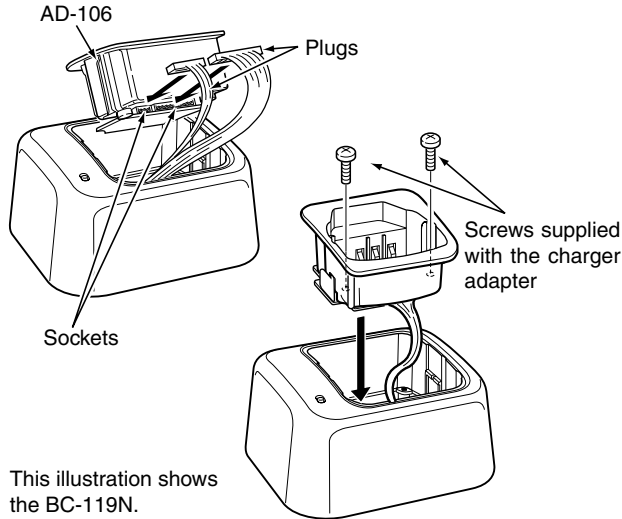

This illustration shows the BC-119N.

◇ **Rapid charging with the BC-119N+AD-106**

The optional BC-119N provides rapid charging of the Li-ion battery pack.

Charging period: Approximately 3 hours (with BP-232H)

The following items are additionally required.

- AD-106 CHARGER ADAPTER (purchase separately)
- An AC adapter (may be supplied with BC-119N depending on version) or the DC power cable (OPC-515L/CP-23L).

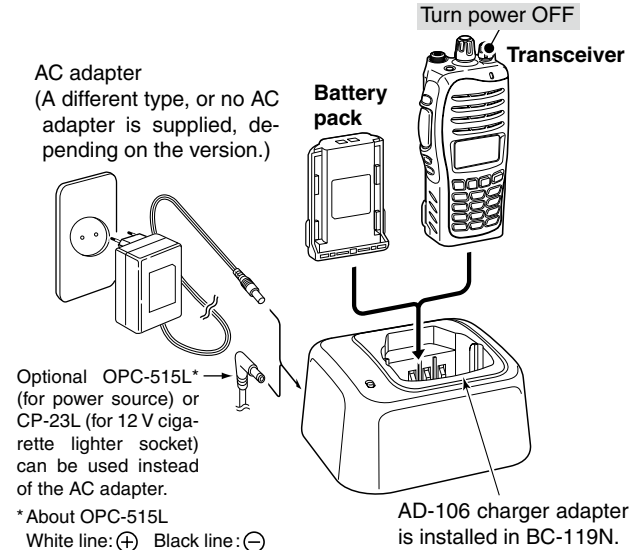

4 BATTERY CHARGING

◇ Rapid charging with the BC-121N+AD-106

The optional BC-121N allows up to 6 battery packs to be charged simultaneously.

Charging period: Approximately 3 hours (with BP-232H)

The following items are additionally required.

- Six AD-106 CHARGER ADAPTERS (purchase separately)
- An AC adapter or the DC power cable (OPC-656)

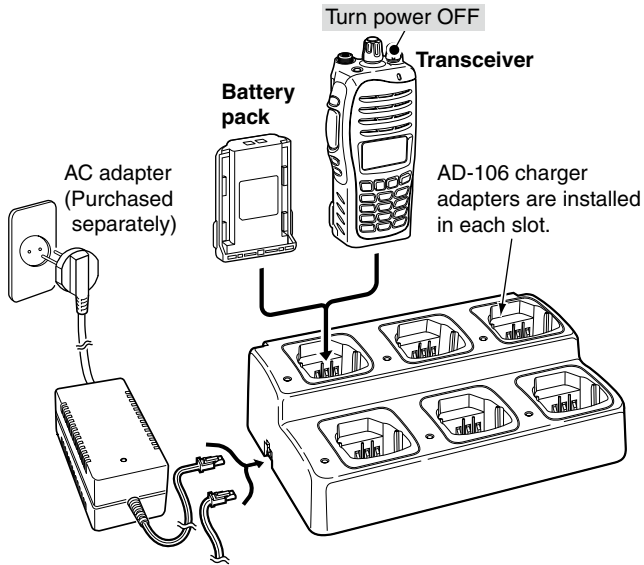

DC power cable (OPC-656*)

(Connect with a DC power supply;
13.8 V/at least 7 A)

*About the OPC-656

Red line: ⊕ Black line: ⊖

IMPORTANT: Battery charging caution

Ensure the guide tabs on the battery pack are correctly aligned with the guide rails inside the charger adapter.
(This illustration shows the BC-160.)

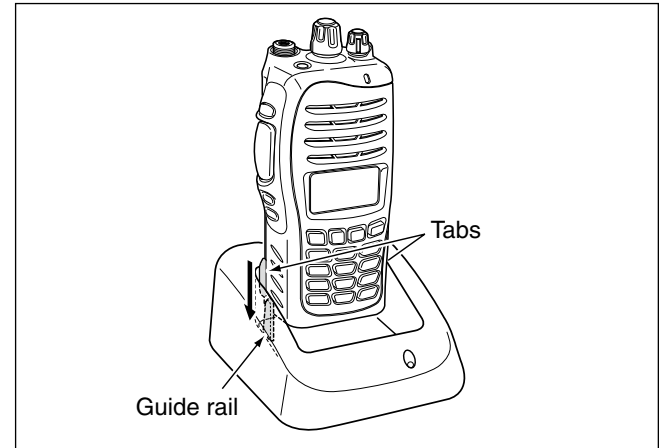

CAUTION:

When using the OPC-515L/OPC-656 DC power cable
NEVER reverse the polarity when connecting the OPC-515L/OPC-656 to a power source. This will ruin the battery charger.

OPC-515L : White line: ⊕, Black line: ⊖

OPC-656 : Red line: ⊕, Black line: ⊖

■ Optional battery case (BP-240)

When using the optional battery case attached to the transceiver, install 6 × AAA (LR03) size alkaline batteries as illustrated at right.

- ① Unhook the battery cover release hook (①), and open the cover in the direction of the arrow (②). (Fig.1)
- ② Then, install 6 × AAA (LR03) size alkaline batteries. (Fig.2)
 - Install the alkaline batteries only.
 - Be sure to observe the correct polarity.
- ③ Fit the cover in the direction of the arrow (③), then close (④). And hook the battery cover release hook until it makes a 'click' sound (⑤). (Fig.3)

CAUTION:

- When installing batteries, make sure they are all the same brand, type and capacity. Also, do not mix new and old batteries together.
- Keep battery terminals clean. It's a good idea to occasionally clean them.
- Never incinerate used battery cells since internal battery gas may cause them to rupture.
- Never expose a detached battery case to water. If the battery case gets wet, be sure to wipe it dry before using it.

NOTE: When the optional battery case is attached, the battery type must be selected to "DRY BATT" when turning the transceiver ON. (p. 11)

Fig.1

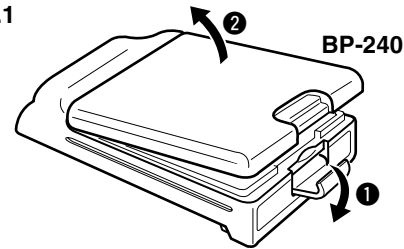

Fig.2

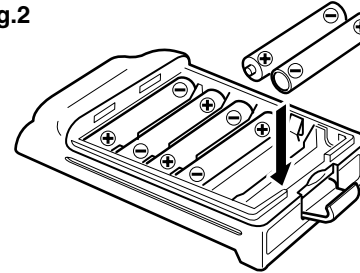
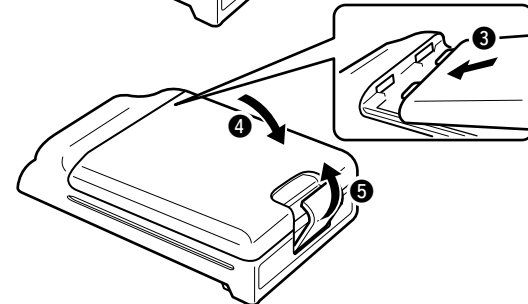

Fig.3



6

SWIVEL BELT CLIP

■ MB-93 contents

	Qty.
① Belt clip	1
② Base clip	1

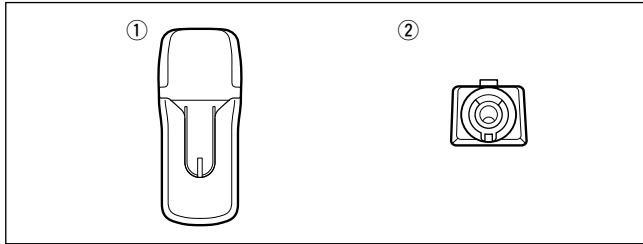

■ To attach

- ① Remove the battery pack if it is attached. (p. 2)
- ② Slide the base clip in the direction of the arrow until the base clip is locked and makes a 'click' sound.

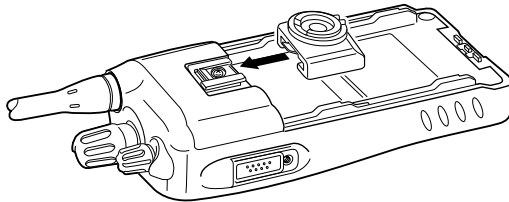

- ③ Attach the battery pack. (p. 2)

- ④ Clip the belt clip to a part of your belt. And insert the transceiver into the belt clip until the base clip inserted fully into the groove.

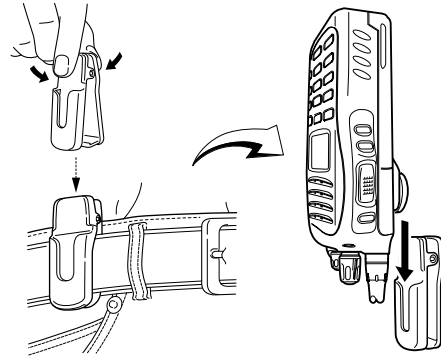

- ⑤ Once the transceiver is locked in place, it swivels as illustrated below.

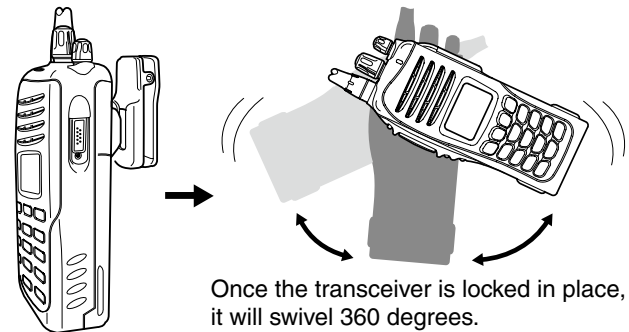

■ To detach

- ① Turn the transceiver upside down in the direction of the arrow and pull out from the belt clip.

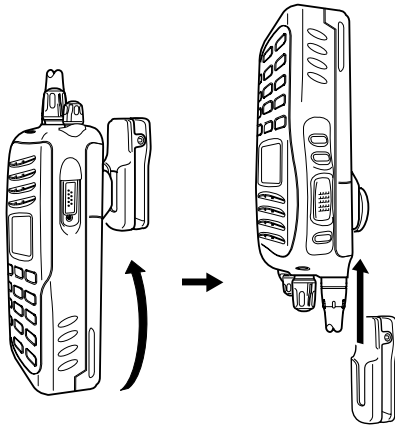

- ② Remove the battery pack if it is attached. (p. 2)
 ③ Pinch the clip (1), and slide the base clip in the direction of the arrow (2).

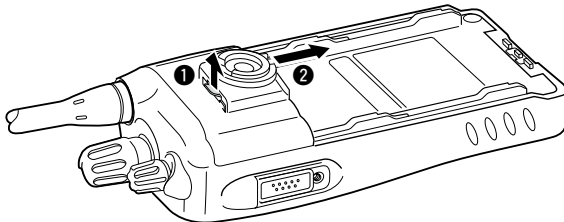

CAUTION:
HOLD THE TRANSCEIVER TIGHTLY, WHEN HANGING OR DETACHING THE TRANSCEIVER FROM THE BELT CLIP.

Otherwise the transceiver may not be attached to the holder or swivel properly if the transceiver is accidentally dropped and the base clip is scratched or damaged.

Optional HM-169/170GP description

TOP KEY

(for HM-170GP only)
Desired functions can be programmed by your dealer.

PTT SWITCH

Push and hold to transmit;
release to receive.

Turn the transceiver power OFF when attaching or detaching the microphone.

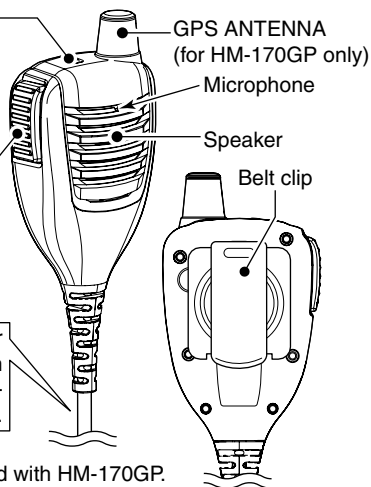

This illustration is described with HM-170GP.

NEVER immerse the connector in water. If the connector becomes wet, be sure to dry it **BEFORE** attaching it to the transceiver.

NOTE: The microphone is located at the top of the speaker-microphone, as shown in the diagram above. To maximize the readability of your transmitted signal (voice), hold the microphone approx. 5 to 10 cm from your mouth, and speak in a normal voice level.

To attach

Attach the connector of the speaker-microphone into the multi connector on the transceiver and tighten the screw.



CAUTION: Attach the multi connector snugly, but do not overtighten. A loose connection will allow water intrusion into the connector; an overtightened connector will damage the connector pins in the transceiver.

IMPORTANT: KEEP the connector cover attached to the transceiver when the speaker-microphone is not in use. (p. 3)
Water will not get into the transceiver even if the cover is not attached, however, the terminals (pins) will become rusty, or the transceiver will function abnormally if the connector becomes wet.

◇ BATTERY PACKS

Battery pack	Voltage	Capacity	Battery life*1
BP-230N	7.4 V	950 mAh (min.) 980 mAh (typ.)	7.35 hrs.
BP-232N	7.4 V	1900 mAh (min.) 2000 mAh (typ.)	12 hrs.
BP-232H	7.4 V	2250 mAh (min.) 2300 mAh (typ.)	14 hrs.
BP-240	Battery case for AAA (LR03) × 6 alkaline		—*2

*1 When the power save function is turned ON, and the operating periods are calculated under the following ratios;

TX : RX : standby = 5 : 5 : 90

*2 Operating period depends on the alkaline cells used.

◇ CHARGERS

- **BC-119N** DESKTOP CHARGER + **AD-106** CHARGER ADAPTER + **BC-145S** AC ADAPTER

For rapid charging of battery pack. An AC adapter is supplied with the charger depending on versions.

Charging period: Approximately 3 hours for the BP-232H.

- **BC-121N** MULTI-CHARGER + **AD-106** CHARGER ADAPTER (6 pcs.) + **BC-157S** AC ADAPTER

For rapid charging of up to 6 battery packs (six AD-106s are required) simultaneously. An AC adapter should be purchased separately.

Charging period: Approximately 3 hours for the BP-232H.

- **BC-160** DESKTOP CHARGER + **BC-145S** AC ADAPTER

For rapid charging of battery pack. An AC adapter is supplied with the charger depending on versions.

Charging period: Approximately 3 hours for the BP-232H.

- **BC-171** DESKTOP CHARGER + **BC-147S** AC ADAPTER

For regular charging of battery packs. We recommend that the BP-230N charging. An AC adapter is supplied with the charger depending on versions.

Charging period: Approximately 4 hours for the BP-230N.

⚡ The BP-232H cannot be charged with the BC-171.

◇ BELT CLIPS

- **MB-93** SWIVEL BELT CLIP
- **MB-94** BELT CLIP
Exclusive alligator-type belt clip.
- **MB-96N/96F** LEATHER BELT HANGER

◇ OPTIONAL UNITS

- **UT-109R /UT-110R** SCRAMBLER UNITS

Non-rolling type (UT-109R)/Rolling type (UT-110R) voice scrambler unit provides higher communication security.

- **UT-126H** DIGITAL MODULATOR/DEMODULATOR UNIT

Provides 6.25 kHz digital mode operation.

- **UT-124R** MAN DOWN UNIT

Provides a measure of safety when working in a hazardous environment, etc.

8 OPTIONS

◇ DC CABLES

- **CP-23L** CIGARETTE LIGHTER CABLE
Allows charging of the battery pack through a 12 V cigarette lighter socket. (For BC-119N/BC-160/BC-171)
- **OPC-515L/OPC-656** DC POWER CABLES
Allows charging of the battery pack using a 13.8 V power source instead of the AC adapter.
OPC-515L : For BC-119N/BC-160/BC-171
OPC-656 : For BC-121N

◇ OTHER OPTIONS

- **SP-13** EARPHONE
Provides clear receive audio in noisy environment.
- **AD-52** EARPHONE ADAPTER
Provides clear receive audio in noisy environment.
- **HM-131SC/HM-159SC** SPEAKER-MICROPHONE
Combination speaker-microphone that provides convenient operation while hanging the transceiver from your belt.
- **HM-169** SPEAKER-MICROPHONE
Rugged type speaker-microphone.
- **HM-170GP** SPEAKER-MICROPHONE
GPS speaker-microphone for BIIS mode operation.
- **VS-1SC** VOX/PTT CASE + **HS-94/HS-95/HS-97** HEADSET
VS-1SC: VOX/PTT switch box for hands-free operation, etc.
HS-94: Ear-hook type
HS-95: Neck-arm type
HS-97: Throat microphone
- **MB-130** VEHICLE CHARGER BRACKET
Vehicle mounting bracket for the BC-160 battery charger.

◇ ANTENNAS

- **FA-SC56VS/FA-SC57VS/FA-SC73US** STUBBY ANTENNAS
Shorter VHF or UHF antennas.
FA-SC56VS: Frequency range 150–162 MHz
FA-SC57VS: Frequency range 160–174 MHz
FA-SC73US: Frequency range 450–490 MHz
- **FA-SC25V/FA-SC55V/FA-SC25U/FA-SC57U/FA-SC72U** FLEXIBLE ANTENNAS
VHF or UHF antennas.
FA-SC25V: Frequency range 136–150 MHz
FA-SC55V: Frequency range 150–174 MHz
FA-SC25U: Frequency range 400–430 MHz
FA-SC57U: Frequency range 430–470 MHz
FA-SC72U: Frequency range 470–520 MHz
- **FA-SC61VC/FA-SC61UC** CUT ANTENNAS
FA-SC61VC: Frequency range 136–174 MHz
FA-SC61UC: Frequency range 380–520 MHz

Approved Icom optional equipment is designed for optimal performance when used with an Icom transceiver. Icom is not responsible for the destruction or damage to an Icom transceiver in the event the Icom transceiver is used with equipment that is not manufactured or approved by Icom.

Some options may not be available in some countries. Please ask your dealer for details.

◇ **About VS-1SC VOX/PTT CASE**

The VS-1SC is a VOX/PTT unit for Icom handheld transceivers, and allows you hands-free operation.

An optional headset (HS-94, etc.) is required for operation.

- The VOX (Voice Operated Transmission) function starts transmission without pushing PTT switch when you speak into the microphone; then, automatically returns to receive when you stop speaking.

Features

- 9-pin Spring-plug type head SP/MIC plug is equipped
- Water resistant construction
- Durable construction
- Equipped with a PTT switch and revolving clip

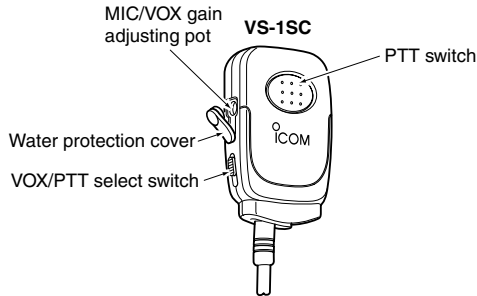

VOX gain and delay adjustment

/// **NOTE:** To adjust the VOX gain and VOX delay, these items must be preset to “enable” by your dealer.

- ① Attach the connector of the VS-1SC into the multi-connector on the transceiver and tighten the screw.
 - Toggle the VOX or PTT select switch to [VOX].
- ② Hold down [SET] for 1 second to enter the user set mode.
- ③ Push [SET] several times to select the “VOX Gain” or “VOX Delay” items. Then, push [CH Up] or [CH Down] to set the desired level or condition.
- ④ Hold down [SET] for 1 second again to exit the user set mode.

• **VOX Gain**

The VOX sensitivity level can be adjusted from OFF or 1 to 6 (more sensitive).

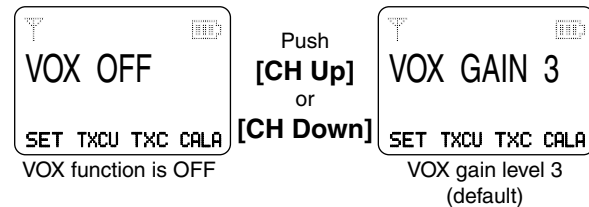

8 OPTIONS

• VOX Delay

The VOX delay time can be set from 0.5 to 3.0 sec. (0.5 sec. step) for a convenient interval before returning to receive.

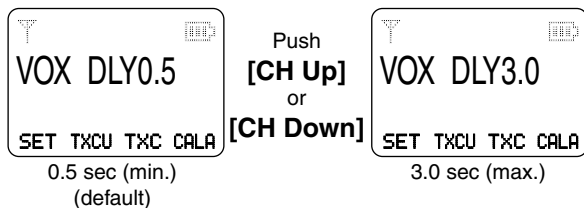

NOTE: MIC/VOX gain can be adjusted via the Adjusting pot using a thin screw driver.

• ISO 3166-1

	Country	Codes		Country	Codes
1	Austria	AT	18	Liechtenstein	LI
2	Belgium	BE	19	Lithuania	LT
3	Bulgaria	BG	20	Luxembourg	LU
4	Croatia	HR	21	Malta	MT
5	Czech Republic	CZ	22	Netherlands	NL
6	Cyprus	CY	23	Norway	NO
7	Denmark	DK	24	Poland	PL
8	Estonia	EE	25	Portugal	PT
9	Finland	FI	26	Romania	RO
10	France	FR	27	Slovakia	SK
11	Germany	DE	28	Slovenia	SI
12	Greece	GR	29	Spain	ES
13	Hungary	HU	30	Sweden	SE
14	Iceland	IS	31	Switzerland	CH
15	Ireland	IE	32	Turkey	TR
16	Italy	IT	33	United Kingdom	GB
17	Latvia	LV			

MEMO

<hr data-bbox="97 210 745 212"/>	<hr data-bbox="812 210 1458 212"/>
<hr data-bbox="97 274 745 276"/>	<hr data-bbox="812 274 1458 276"/>
<hr data-bbox="97 338 745 340"/>	<hr data-bbox="812 338 1458 340"/>
<hr data-bbox="97 402 745 404"/>	<hr data-bbox="812 402 1458 404"/>
<hr data-bbox="97 465 745 468"/>	<hr data-bbox="812 465 1458 468"/>
<hr data-bbox="97 529 745 532"/>	<hr data-bbox="812 529 1458 532"/>
<hr data-bbox="97 593 745 595"/>	<hr data-bbox="812 593 1458 595"/>
<hr data-bbox="97 657 745 659"/>	<hr data-bbox="812 657 1458 659"/>
<hr data-bbox="97 719 745 721"/>	<hr data-bbox="812 719 1458 721"/>
<hr data-bbox="97 782 745 785"/>	<hr data-bbox="812 782 1458 785"/>
<hr data-bbox="97 846 745 848"/>	<hr data-bbox="812 846 1458 848"/>
<hr data-bbox="97 908 745 910"/>	<hr data-bbox="812 908 1458 910"/>
<hr data-bbox="97 972 745 974"/>	<hr data-bbox="812 972 1458 974"/>
<hr data-bbox="97 1033 745 1036"/>	<hr data-bbox="812 1033 1458 1036"/>

Count on us!

< Intended Country of Use >

AT BE CY CZ DK EE
FI FR DE GR HU IE
IT LV LT LU MT NL
PL PT SK SI ES SE
GB IS LI NO CH BG
RO TR HR

A-6639H-1EU-⑧

Printed in Japan

© 2008–2013 Icom Inc.

Printed on recycled paper with soy ink.

Icom Inc.

1-1-32 Kamiminami, Hirano-ku, Osaka 547-0003, Japan